

Powerbolt 240

KEYPAD ELECTRONIC LOCK

Installation and User Guide

Kwikset Technical Support | 1-800-327-5625 | www.kwikset.com

Required tools

Batteries Ruler Screwdrivers

Additional Tools (depending on application)

Hammer Wood block

3D instructions available on

SCAN FOR BILT 3D INSTRUCTIONS

POWERED BY BILT INTELLIGENT INSTRUCTIONS™

Parts in the box

Latch	Interior Assembly	Exterior Assembly		
		Contemporary	Traditional	Transitional
Mounting Plate	Strike	For Latch / Strike		
		52502		
Collar	Key	For Lock		
		53648		
		53646		

1 Prepare the door and check dimensions

If drilling a new door, use the supplied template and the complete door drilling instructions available at www.kwikset.com/doorprep.

A Measure to confirm that the hole in the door is either 2-1/8 in (54 mm) or 1-1/2 in (38 mm).

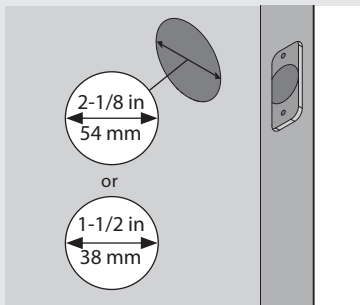

Note: Additional door preparation may be required for doors with 1-1/2 in (38 mm) holes. Consult the deadbolt drilling instructions at www.kwikset.com/doorprep.

B Measure to confirm that the backset is either 2-3/8 or 2-3/4 in (60 or 70 mm).

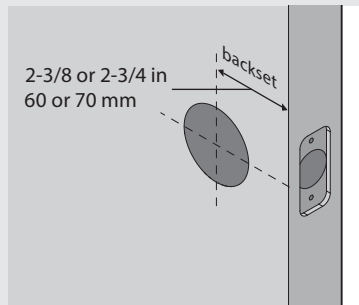

C Measure to confirm that the hole in the door edge is 1 in (25 mm).

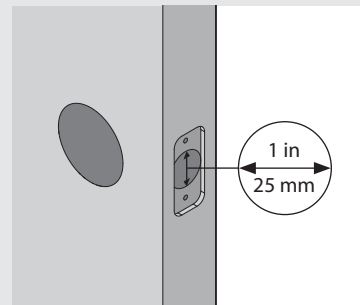

D Measure to confirm that the door is between 1-3/8 and 1-3/4 in (35 mm and 44 mm) thick.

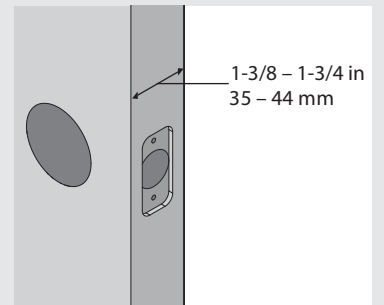

Note: Please contact customer service if door thickness exceeds 1-3/4 in for a thick door kit.

2 Install the latch and strike

For Latch / Strike Bag

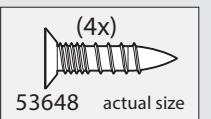

A Hold the latch in front of the door hole, with the latch face flush against the door edge.

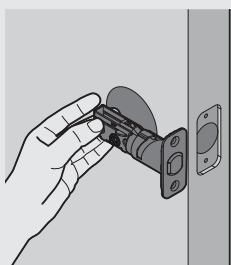

Is the rectangular shaped hole centered in the door hole?

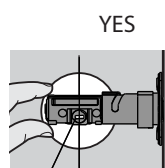

YES
Rectangular shaped hole
No adjustment is required. Proceed to next step.

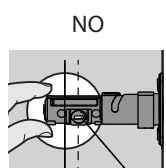

NO
Rectangular shaped hole
Rotate latch face as shown to extend latch.

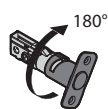

B Is the door edge chiseled?

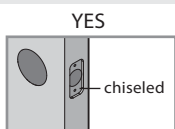

YES
chiseled
Install latch in door with supplied screws.

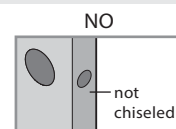

NO
not chiseled
Use a flathead screwdriver to remove latch face. Once removed, grip the latch with one hand and with the other hand twist collar off. Install drive-in collar.

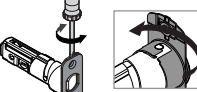

Align tabs with holes in collar.



Ensure collar snaps into place. Pull collar to test for tight fit.

Install latch in door with wood block and hammer.

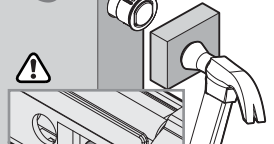

Make sure slotted hole is at bottom of latch.

C Install strike on the door frame.

⚠ Make sure the hole in the door frame is drilled a minimum of 1 in (25 mm) deep.

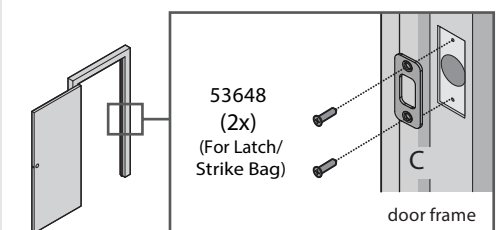

D ⚠ IMPORTANT: Make sure the latch bolt is fully retracted (in the unlocked position).

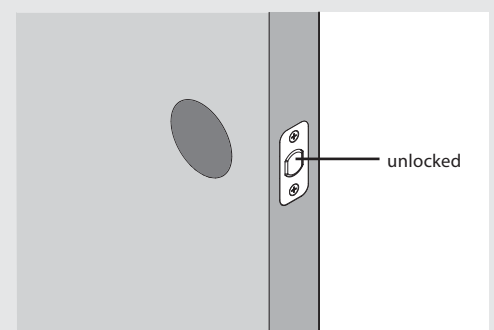

3 Install the exterior keypad

For Lock Bag

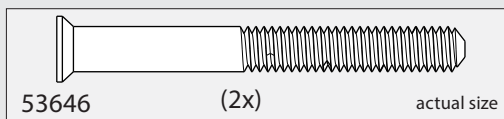

A What is the diameter of the hole in the door?

<p>Diameter is 2-1/8 in (54 mm)</p> <p>Adapter ring is required for installation.</p>	<p>or</p>	<p>Diameter is 1-1/2 in (38 mm)</p> <p>Adapter ring is not needed for installation.</p>
---	-----------	---

B Locate screws for step 3C and keep them within reach.

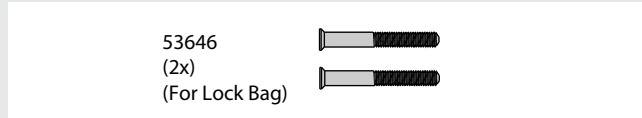

C Install exterior keypad and mounting plate.

<p>a</p> <p>Rotate the flat blade to a horizontal position to match the latch orientation.</p> <p>Cable goes underneath latch.</p> <p>Make sure door is retracted.</p>	<p>b</p> <p>Support exterior assembly during mounting plate installation.</p> <p>Route cable through center hole, then push cable into bottom hole.</p>
<p>c</p> <p>Tighten screws evenly. DO NOT over tighten screws.</p> <p>TOP of the mounting plate should be visible. Keep parallel to edge of door.</p> <p>Make sure the flat blade is centered in the mounting plate hole.</p> <p>53646 (2x) (For Lock Bag)</p>	<p>d</p> <p>Insert key and test latch. If latch does not extend or retract smoothly, adjust screws.</p> <p>Remove key when finished and make sure the latch bolt is FULLY EXTENDED.</p>

4 Install the interior assembly

For Lock Bag

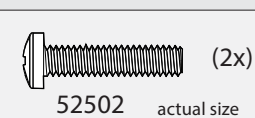

A Remove interior cover from interior assembly.

<p>a</p> <p>Check to make sure the latch bolt is in the extended/locked position to install the interior assembly.</p>	<p>b</p> <p>Make sure turnpiece shaft is rotated as shown.</p> <p>If the turnpiece is not pointing up, rotate the turnpiece until you hear a click.</p>
<p>c</p> <p>Remove the interior cover from the interior assembly.</p>	<p>d</p> <p>Do not install batteries until step 5.</p>

B Secure the interior assembly onto the mounting plate.

<p>a</p> <p>Connect the cable. Ensure a tight cable connection.</p>	<p>b</p> <p>Route cable around the side notch and bottom of the interior assembly.</p>
<p>c</p> <p>Insert the flat blade into the turnpiece shaft.</p>	<p>d</p> <p>Ensure you are using the correct screws. Using incorrect screws will damage the product.</p> <p>52502 (2x)</p>

5 Install the batteries in the interior assembly

A Install 4 AA batteries in interior assembly

Ensure your door is open while installing batteries. Ensure the interior cover is off to install batteries. Note: Batteries are not included

Ensure correct polarity. For best results, use new, non-rechargeable alkaline batteries only.

B Install interior cover for the interior assembly.

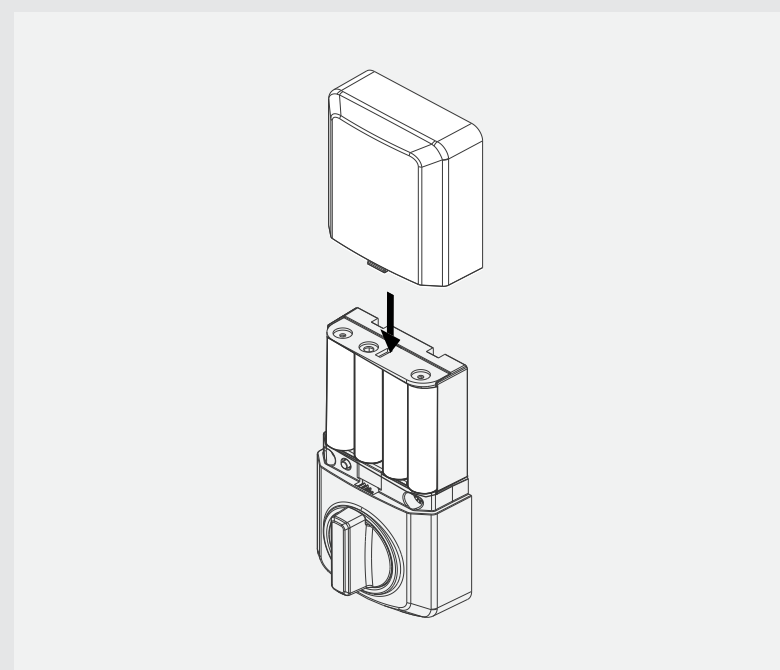

6 Add user codes (12 max)

A Make sure the interior cover is off. Press the Program button once.

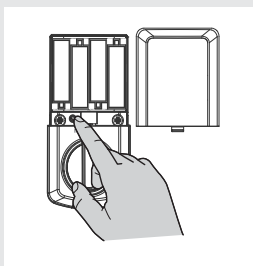

B Press number 12.

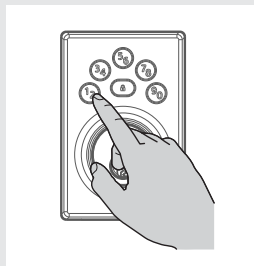

C Press the button once.

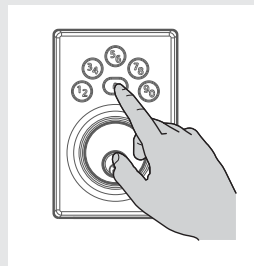

D Enter user code. A total of 12 user codes may be programmed. User codes should be 4 to 8 digits in length.

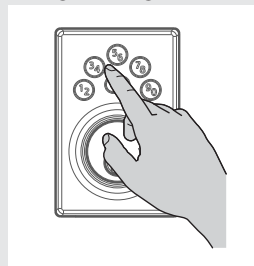

E Press the button again.

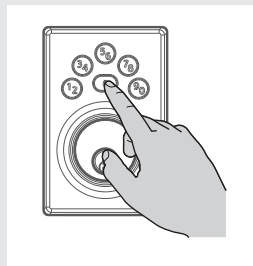

During User Code programming, a time out will occur if the keypad is not pressed for 5 seconds and you will need to restart the procedure.

⚠ For security reasons, the first 4 digits of each User Code must be unique. For example, you are unable to program a user code 1-2-3-4-5 as well as user code 1-2-3-4-6.

Note: After the first User Code is created, the latch bolt will automatically retract and extend to learn the locking and unlocking direction of the door. The lock button will indicate success or failure. GREEN: Success RED: Unsuccessful

7 Test the lock (review normal operation)

⚠ Before you can lock and unlock the door a User Code must be created. Refer to Step 6 for instructions how to create a User Code. Confirm that the code(s) added in previous step can unlock the door.

A To lock your door, press the lock button. The lock will beep twice and the lock button will flash amber as the deadbolt extends.

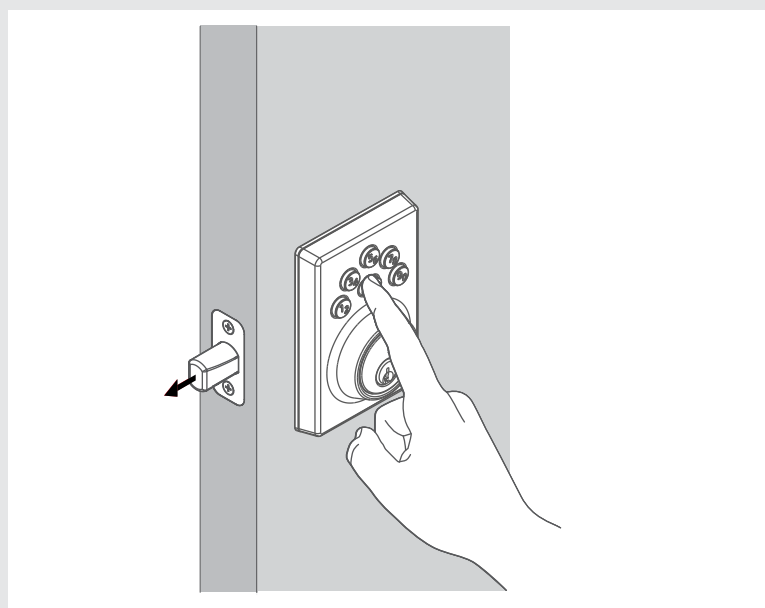

B To unlock your door, enter the user code. The lock will beep twice and the lock button will flash green and the deadbolt retracts.



8 Adding a One-time User Code

1. Remove interior cover. Press programming button.

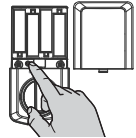

2. Press number 12.

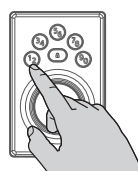

3. Press number 56.

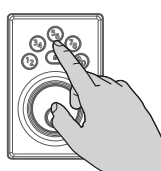

4. Press the button.

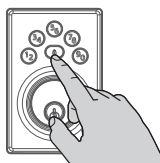

5. Enter the one time user code.

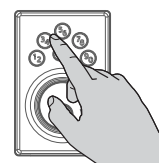

6. Press the button again.

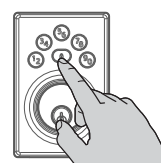

Up to 2 One-time User Codes can be saved. One-time User Codes should be 4 to 8 digits in length. The One-Time User Code will be deleted automatically after it is used. The same One-Time User Code can be created again after it's used.

9 Delete a Single User Code

1. Remove interior cover. Press programming button.

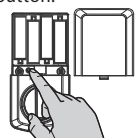

2. Press number 34.



3. Press the button.



4. Enter the user code you want to delete.



5. Press the button again.



6. Enter the user code being deleted again.



7. Press the button again.



If unsuccessful: Make sure you entered the same user code in steps 4 and 6.

⚠ Test code while the door is open. Test the User Code to make sure it no longer unlocks the door.

If a button is not pressed within 5 seconds, the system will time out, and you will need to restart the procedure.

10 Delete ALL User Codes

Note: Keypad locking function will be disabled when User Codes are deleted. The lock can only be operated manually by a key during this time.

1. Remove interior cover. Press programming button.

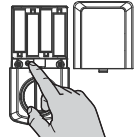

2. Press number 78.

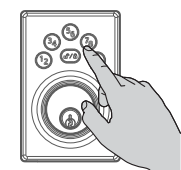

3. Press the button.



4. Press number 78.

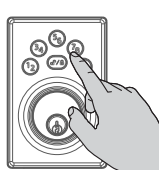

5. Press the button again.

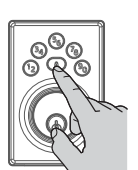

11 Enable/ Disable Audio

1. Remove interior cover. Press programming button.

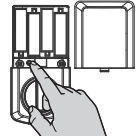

2. Press number 12.

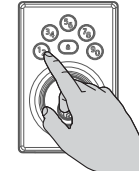

3. Press number 12 again.



4. Press the button.



Note: LED status indicator will still function once audio is disabled. Repeat the programming steps to enable the audio.

12 Enable/ Disable User Codes

Note: When all User Codes are disabled, all electronic functions will be disabled as well. The door must be locked or unlocked manually with the key. Repeat the programming steps to enable the User Codes.

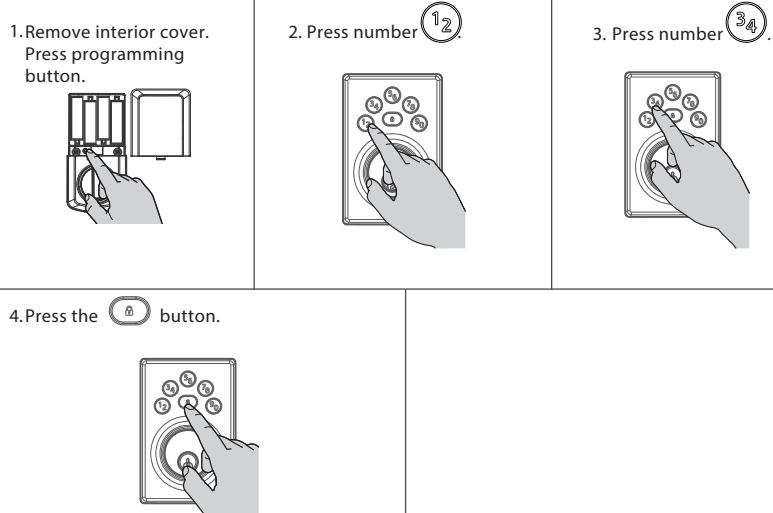

13 Enable/ Disable Auto-Lock

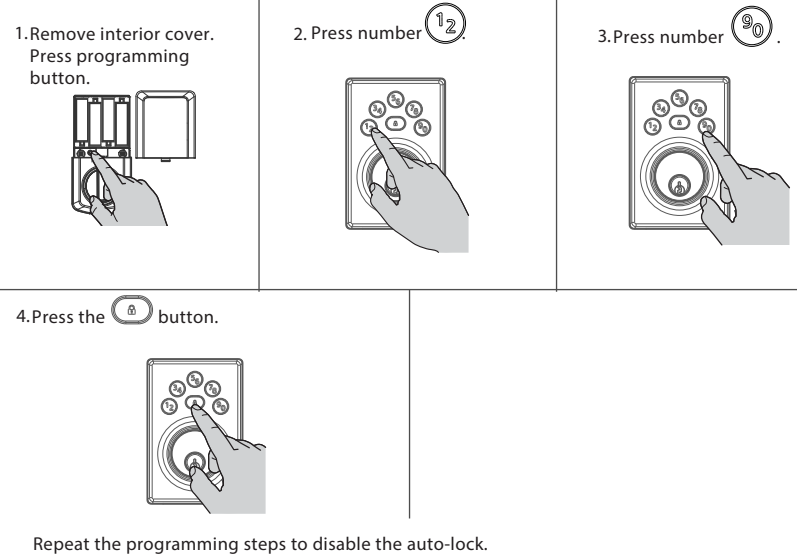

14 Change Auto-Lock Time Delay

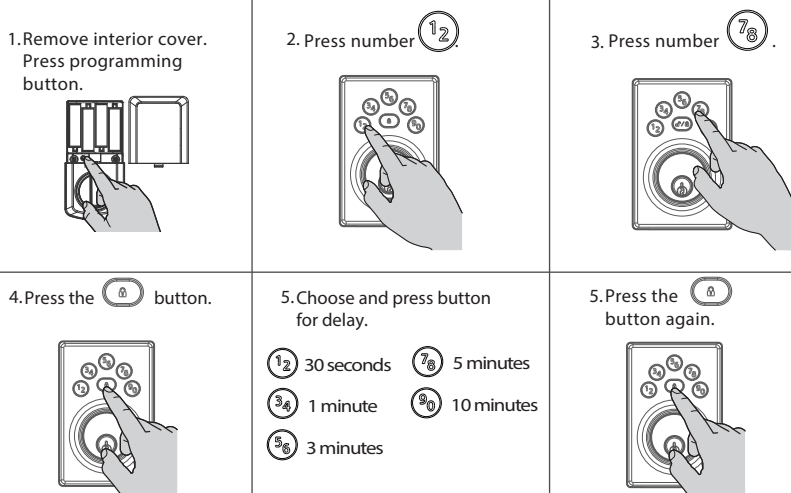

15 Door Rehanding

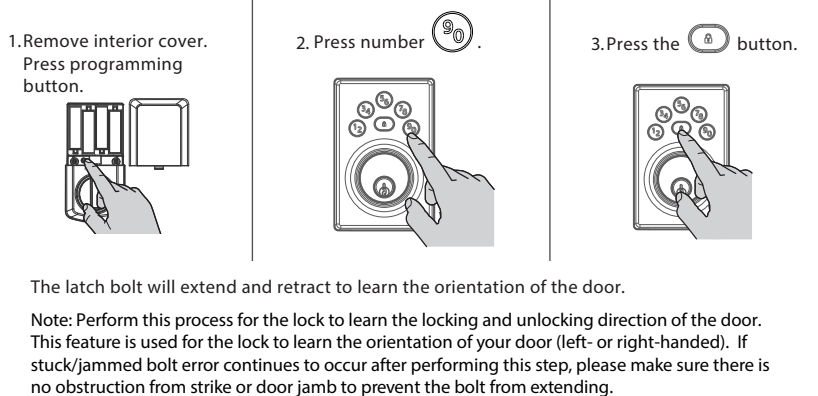

16 Factory Reset

⚠ Note: Lock must be in an unlocked position to factory reset.

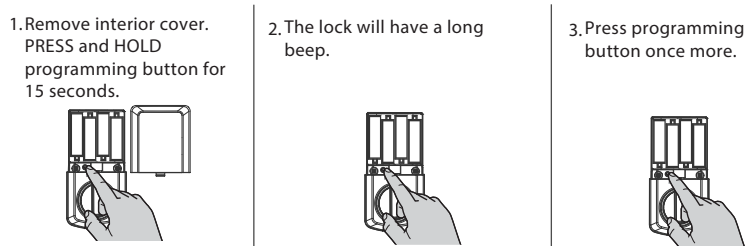

A factory reset will delete all User Codes and change all programming to factory settings. At this time, the lock can only be locked or unlocked manually with the key.

17 Add/ Change Programming Code

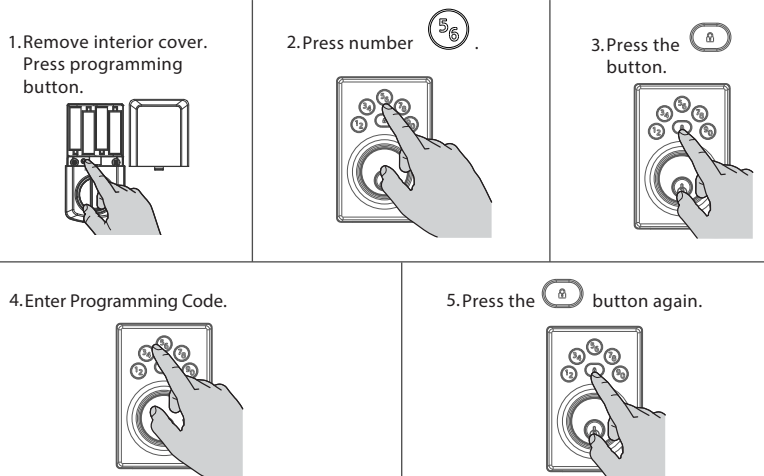

Enable/ Disable Programming Code:

Optional: A Programming Code enables you to make programming changes without needing to access the Programming Button. This is ideal for landlords to program the lock without access to the interior programming button.

Note: Once Programming Code is enabled, the Programming Button is disabled and can only be used to factory reset the lock.

One Programming Code between 4 to 8 digits can be saved and cannot be the same as any User Code and cannot be used as a User Code to unlock the lock.

To program the lock with Programming Code:

Programming Code → Lock Button → Follow the programming steps WITHOUT PRESSING the PROGRAMMING BUTTON

To disable Programming Code:

Programming Code → Lock Button → 56 → Lock Button → Programming Code → Lock Button

Powerbolt at a Glance

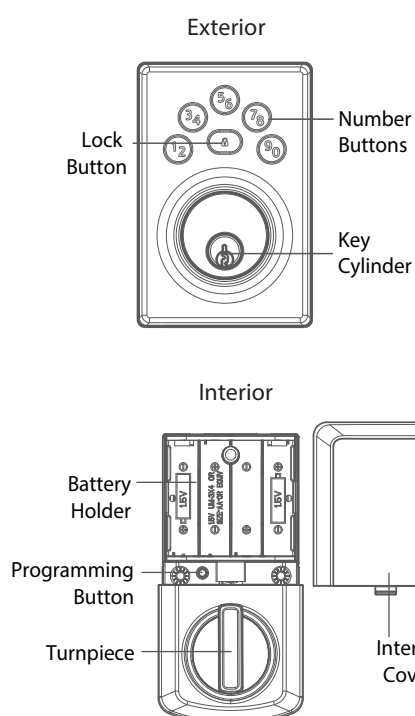

System Alerts

Action	Lights	Sounds	Troubleshoot
Successful Unlock	Flashes GREEN x2	2 beeps	
Successful Lock	Flashes AMBER x2	2 beeps	
Low battery	Flashes RED x10	10 beeps	Install fresh new batteries
Incorrect User Code	Flashes RED x 3	3 beeps	Check code, and retry
Exceed 3 incorrect User Code attempts	Flashes RED x15	15 beeps	Wait 1 minute, check code, and retry
Stuck/Jammed bolt	Alternate RED/ WHITE Flash x5	5 beeps	Clear jam and try again
Factory Reset Successful	Flashes GREEN x1	1 beep	
Factory Reset Unsuccessful	Flashes RED x3	3 beeps	Retry factory reset steps. Make sure to press the Programming Button one more time within 10 seconds after the long beep.
Programming Successful	Flashes GREEN x1	1 beep	
Programming Unsuccessful	Flashes RED x3	3 beeps	Review Programming steps

Important Safeguards

1. Read all instructions in their entirety.
2. Familiarize yourself with all warning and caution statements.
3. Remind all family members of safety precautions.
4. Always have access to your lock's standard key.
5. If using the Auto-Lock features, make sure you have your standard key with you to prevent locking yourself out.
6. Familiarize yourself with the system alerts.
7. Replace low batteries immediately.
8. Dispose of used batteries according to local laws and regulations.

⚠ WARNING:

This Manufacturer advises that no lock can provide complete security by itself. This lock may be defeated by forcible or technical means, or evaded by entry elsewhere on the property. No lock can substitute for caution, awareness of your environment, and common sense. Builder's hardware is available in multiple performance grades to suit the application. In order to enhance security and reduce risk, you should consult a qualified locksmith or other security professional.

⚠ CAUTION:

Prevent unauthorized entry. Since anyone with access to the back panel can change the User Codes, you must restrict access to the back panel and routinely check the User Codes to ensure they have not been altered without your knowledge. The use of a programming code can help protect your system's settings.