



Welcome to the Kwikset family!

This guide will get you ready to install your new deadbolt.

If you have any issues, please visit our support center: kwikset.com/support or call us at 1-800-327-5625.

Installation and Reference Guide

This manual can be used to install a variety of dead bolt. Please determine your function type prior to installation.



Entry
(Keyed)

Recommended Tools

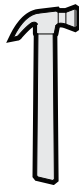
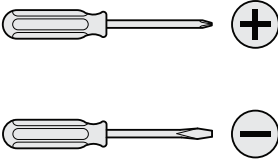

wood block

*Tools will depend on install type

[Door Prep: If you need help in preparing your door](#)
[Drilling template](#)

1 Extend latch bolt

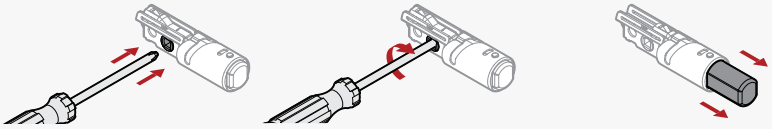

2 Adjust backset of the latch (if needed)

A Hold the latch in front of the door hole, with the latch face flush against the door edge.

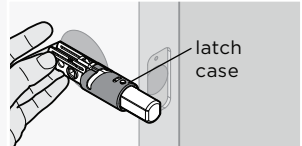

B If the latch holes are centered in the door hole, no adjustment is required. Proceed to step 3.

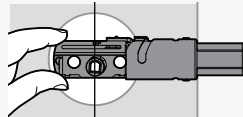

centered

If the D-shaped hole is NOT centered, adjust latch. See "Latch Adjustment" (step C).

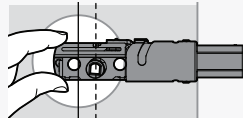

not centered

C Latch Adjustment (only if needed)

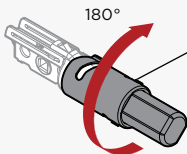

Rotate the front of the latch to extend it.

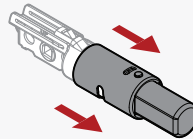

3 Prepare latch for installation (if not pre-assembled)



or



Install plate.

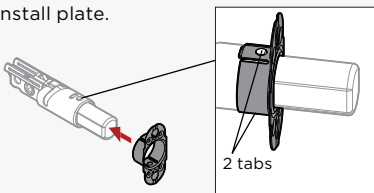

Ensure plate snaps into place.
⚠ Pull plate to test for tight fit.

Install collar.

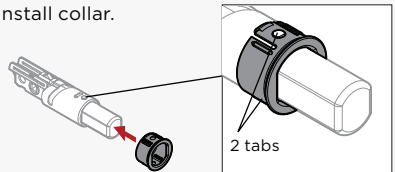

Ensure collar snaps into place.
⚠ Pull plate to test for tight fit.

4 Install latch (chiseled door)

A

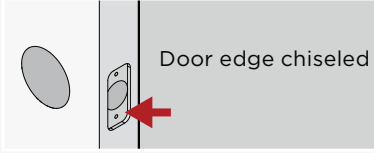

B Install latch.

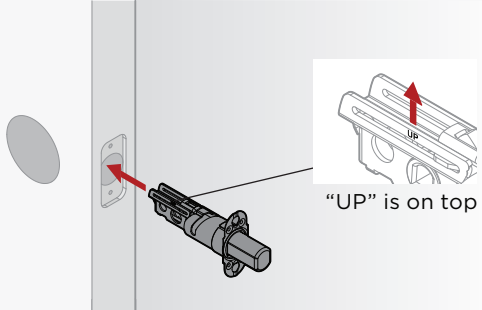

C Install front plate.

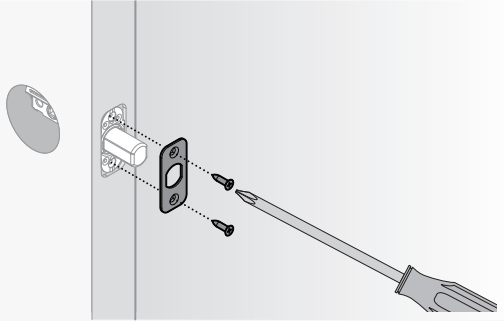

4 Install latch (non-chiseled door)

A



B Retract latch bolt.

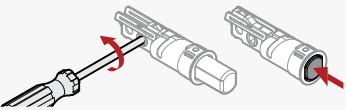

C Install latch.

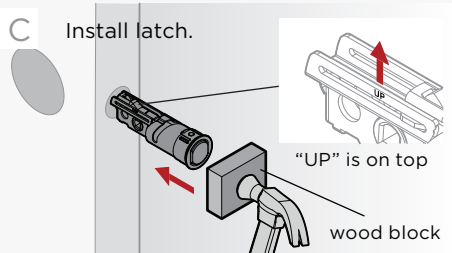

D Extend latch bolt.

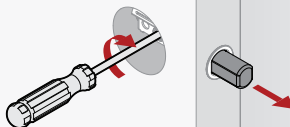

5 Install deadbolt

A *For double cylinders only:* Remove cover plate from interior cylinder.



Remove interior cylinder.



Interior cylinder has holes.

Pull paper tab to remove cover plate.



cover plate

Reinstall cylinder. Do not reinstall cover plate.

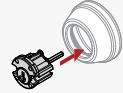

B Install deadbolt exterior.

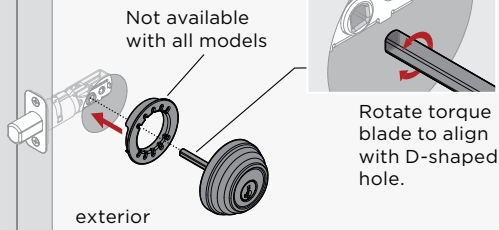

C Install deadbolt interior.

(Ring adapter available with some models)

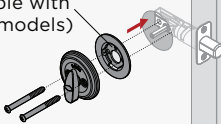

interior

or

The cylinder with holes should be installed on the interior side of the door.

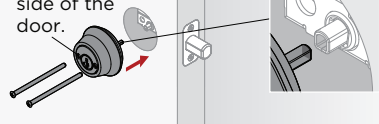

interior

Insert interior torque blade into exterior torque blade.

6 Install strike on door frame

A

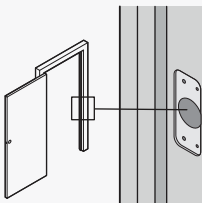

Make sure hole in door frame is drilled a minimum of 1" (25mm) deep.

B

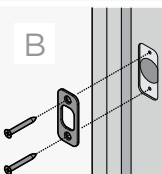

or

Longer screws install closest to jamb.

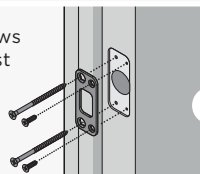

or

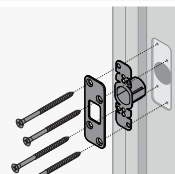

SmartKey Rekeying Instructions



SMARTKEY
SECURITY™

**ONE KEY
FOR ALL
YOUR LOCKS™**



WITH PROTECTION AGAINST
ADVANCED BREAK-IN TECHNIQUES

The lock you can
re-key yourself in
seconds for any
situation, including:



**Recently
Moved**



**Lost
Keys**



**Multiple
Doors**



**Carry
Less Keys**

For rekeying instructions, you can also visit:

<https://www.kwikset.com/support/answers/how-to-re-key-your-smartkey-security-locks>

If you have any issues, please visit our
support center: [kwikset.com/support](https://www.kwikset.com/support)
or call us at 1-800-327-5625.



WARNING: This Manufacturer advises that no lock can provide complete security by itself. This lock may be defeated by forcible or technical means, or evaded by entry elsewhere on the property. No lock can substitute for caution, awareness of your environment, and common sense. Builder's hardware is available in multiple performance grades to suit the application. In order to enhance security and reduce risk, you should consult a qualified locksmith or other security professional.